

**BRUSH DESIGNS**

**Mono brushes**

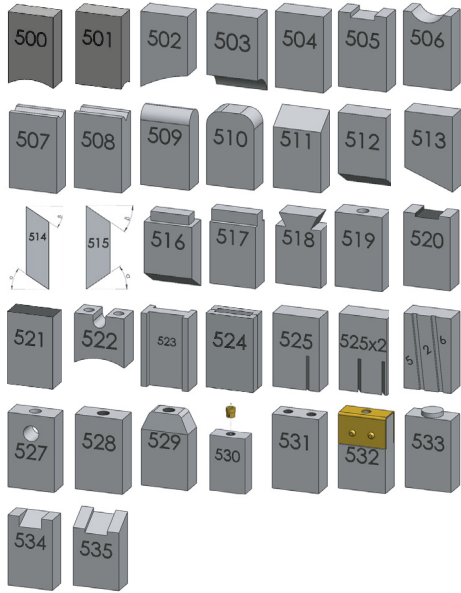

**Brush parts**

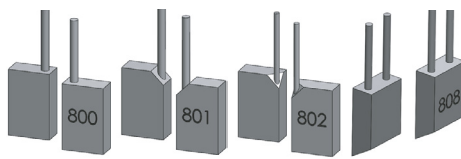

**Split brushes**

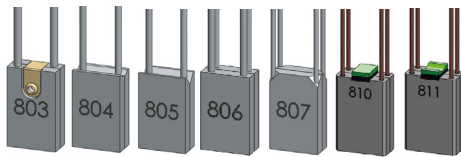

**With one flexible**

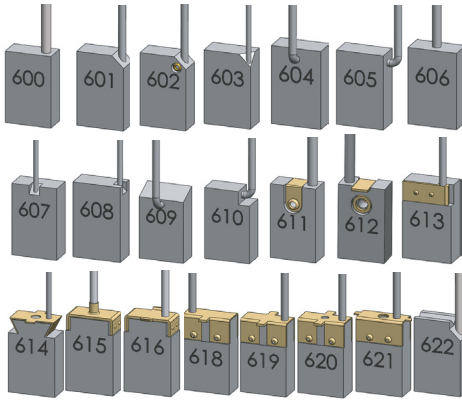

**With two flexibles**

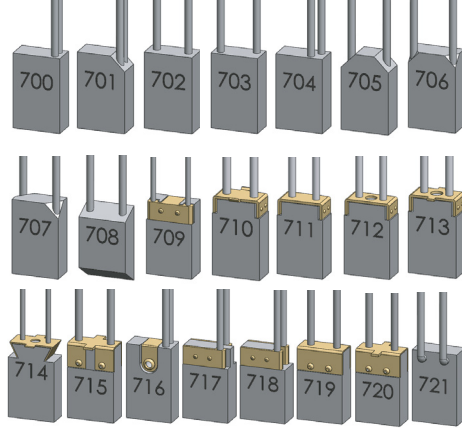

**Top inserts**

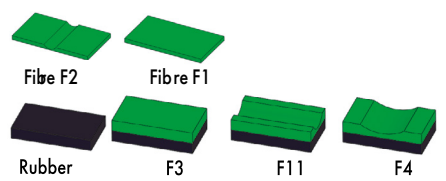

**Terminals**

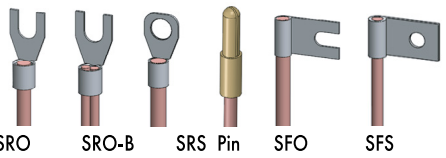

**SDO, SDO-B, Flat pin connector, Flexible placing**

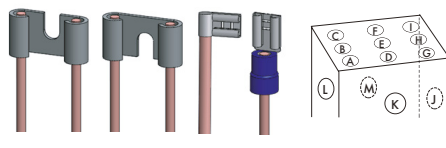

**Flexible length**

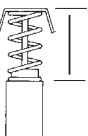

**Flexible placing**

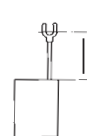

**Radius (mm)**

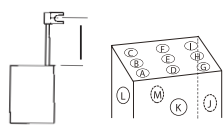

**Commutator**

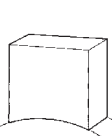

**Slipping**

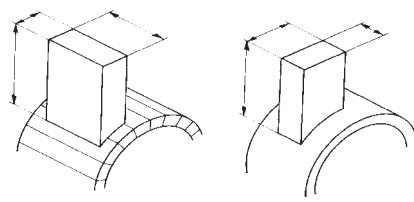

BEYOND THE BOUNDARIES OF BRUSH TECHNOLOGY

**CARBON BRUSH ACQUISITION FORM**

Company: \_\_\_\_\_ Contact: \_\_\_\_\_ Order number: \_\_\_\_\_

Address: \_\_\_\_\_ Postal code: \_\_\_\_\_ Delivery postal address: \_\_\_\_\_

Phone: \_\_\_\_\_ Fax: \_\_\_\_\_ E-mail: \_\_\_\_\_ Country: \_\_\_\_\_

Delivery date: \_\_\_\_\_

**BRUSH DATA**

Quantity: \_\_\_\_\_ pcs

Brand: \_\_\_\_\_

Grade: \_\_\_\_\_

Design no: \_\_\_\_\_

Other  Copper graphite  Silver graphite

**DIMENSIONS**

(t) Tangential: \_\_\_\_\_ mm

(a) Axial: \_\_\_\_\_ mm

(r) Radial: \_\_\_\_\_ mm

**FLEXIBLE**

Quantity: \_\_\_\_\_ pcs

Length: \_\_\_\_\_ mm

Insulation: Silicon  Glass fibre  Tinned flexible

**TERMINAL**

Type: \_\_\_\_\_

Opening: \_\_\_\_\_ mm

Flexible placing: \_\_\_\_\_

Sketch & notes

---



---



---

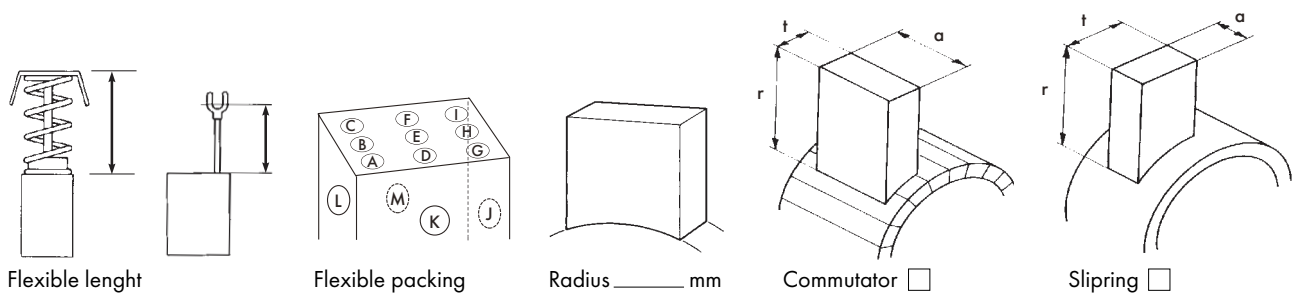

BEYOND THE BOUNDARIES OF BRUSH TECHNOLOGY